

Vacuum Mixer Wamix-Comfort IV



USER MANUAL

Dear customer,

Thank you for choosing a product from the Wassermann range. Wassermann Dental-Maschinen incorporates the highest standards of quality and the latest technology. In order to enjoy maximum performance and years of trouble-free operation, please read this user manual carefully before you connect this device and start work, and operate the device according to the recommended guidelines. The operation safety and the functionality of this device can only be guaranteed if you follow both the general safety guidelines and the applying laws to prevent accidents as well as the precautions given in this user manual. We are not liable for any damages which occur due to inappropriate usage or faulty operation of this device.



Make sure that anyone using this device has read and understood this user manual.

Keep this user manual in a safe place where it can be referred to as required at any time.



The unit complies with the relevant EU guidelines.



The unit is subject to the EU guidelines 2012/19/EU (WEEE Directive).

Company address:

Wassermann Dental-Maschinen GmbH

Rudorffweg 15-17

21031 Hamburg, Germany

Phone : +49 (0)40 730 926 -20/ -24 Fax.: +49 (0)40 730 37 24

export@wassermann-dental.com

www.wassermann.hamburg

Contents

1 Features.....	4
2 Safety symbols used in this manual.....	5
3 Safety guidelines.....	5
4 Responsibility for operation or damage.....	6
5 Application.....	6
6 Before starting.....	7
6.1 Transport.....	7
6.2 Installation.....	7
6.3 Storage.....	7
6.4 Mounting instruction fastening set for wall mounting.....	8
7 Installation / Start-up.....	11
8 Operation.....	12
8.1 General operating instructions.....	12
8.1.1 Speed adjustment.....	13
8.2 Operation / Programming Wamix-Comfort IV.....	14
8.2.1 Starting the automatic program with vacuum.....	14
8.2.2 Changing from German to English.....	15
8.2.3 Programming.....	15
8.2.4 Sequence: (first time).....	15
8.2.5 Starting program 01 (to 15).....	18
8.2.6 Changing between main and program menu.....	19
8.2.7 Interrupting program with START / STOP button.....	19
8.2.8 Changing the time during program operation.....	19
9 Troubleshooting.....	20
10 Care and maintenance.....	21
10.1 Cleaning.....	21
10.2 Maintenance.....	22
10.2.1 Changing the filter.....	22
10.3 Warranty.....	23
10.4 Spare Parts.....	23
10.5 Service Hotline 0049 (0)40 730 926 -20/ -24.....	23
10.6 Scope of delivery/ Accessories.....	24
10.7 Repairs.....	24
11 Technical data.....	25
12 Disposing of the unit.....	25
12.1 Information on disposal for countries within the EU.....	25
13 EU Declaration of Conformity.....	26
14 Spare part diagram.....	27
15 Wiring diagram.....	30

1 Features

The **Wamix units** are vacuum mixers used not only for mixing all kinds of plasters, embedding media and silicones, but also designed for specialised dental procedures and for vacuum-rinsing of prostheses.

When mixing silicones, make sure that the beaker is **only filled to the max. height for silicone**. Otherwise, silicone could penetrate the interior of the unit itself. A control window on the device makes overfilling visible (see fig. 3).

Units have separate drives for vacuum generation and for the mixing mechanism. The agitator of the **Wamix-Comfort IV** can be turned on and off individually at all times without interrupting the vacuum. An audible signal indicates the end of the mixing process.

This is controlled by a microchip in the **Wamix-Comfort IV** model. Because the mixing beaker on the **Wamix-Comfort IV** is held to the rim by vacuum, a vacuum is guaranteed.

Mixers are supplied as wall units, but can be converted for tabletop use at any time.

(For accessories, see 8.5)

- well designed and compact vacuum stirrers with powerful, maintenance-free motors
- perfect mixing of all kinds of plaster, embedding materials and silicone
- user-friendly electronic menu guide with multiple adjustment options, languages: German/English
- vacuum comes standard up to 900 mbar thanks to powerful and maintenance-free motorised pump
- speed regulation of the agitator from 200 – 600 rpm
- audible signal at programme end / illuminated LCD display
- mixing time adjustable up to 4 minutes / automatic mixing when beaker is applied
- beaker vented only after ON/OFF switch activated
- inclination of the cup mount allows easy attachment of the cup and optimal mixing results
- 350 ml beaker and wall bracket supplied, table stand and other beaker sizes available as extras

2 Safety symbols used in this manual



Warning!

This is a warning of risk situations and dangers.

Failure to observe this warning could be life-threatening. These warnings has to be observed.



Information!

This symbol draws your attention to specific features that has to be observed.

3 Safety guidelines

Configuring and operating this equipment requires **precise knowledge** and **observance** of the instructions in this **user manual**. The equipment is designed only for its intended application.



WARNING:

Servicing and repairs should be carried out only by authorised specialists.



This equipment is designed to operate at 220-240 V, 50/60 Hz.

Make sure it is always connected to the appropriate power supply.

Always remove the plug from the power socket before undertaking maintenance or cleaning work.

A locking hook underneath each unit prevents it coming loose once it has been mounted in the bracket.

Allow the condensers to discharge before opening the unit.

4 Responsibility for operation or damage

The responsibility for operating the device lies exclusively with the owner or user if said device is incorrectly serviced, maintained or altered by persons not employed by an authorised dealer or if the device is used in a manner contrary to its specified purpose.

The unit has to be maintained and operated in accordance with this user manual.

Wassermann Dental-Maschinen GmbH is not responsible for damage arising from the **nonobservance** of these instructions.

Warranty and responsibility provisions contained in the sales and supply conditions of Wassermann Dental-Maschinen GmbH are not extended by these instructions.

5 Application

Wamix units are used for mixing all kinds of plasters, embedding media and silicones under vacuum.

This unit is also suitable for vacuum rinsing of models for special dental procedures. The insulating layer between the model and the prosthesis cannot separate prematurely because the model remains moister in the pressure-embedding unit than when water is used.

Only use the device for this type of application.

6 Before starting

6.1 Transport

Before transporting the unit, ensure that it has been unplugged from the power socket. Make sure that it is packed correctly in order to avoid accidental damage.

 Be sure to check for any transport damage when unpacking the goods. Note down any damage if found.

6.2 Installation

Open the box, remove the packing materials, and carefully lift out the device and accessories. Check the included accessories.

The device has to stand horizontally on a steady and even surface or may be mounted horizontally to a stable wall using the wall bracket (included in delivery).

If **mounting on a wall**, ensure that the wall is strong enough to support the unit. Detach the wall mount from the unit and use it as a template for drawing a **drilling scheme** to drill the \varnothing 8 mm diameter dowel holes. Leave at least 30-35 cm free space beneath the unit.

Use the following hole template (page 8) if mounting the unit on a wall:



Install the device in a place where it will not block the working area and the functionality (take the dimensions into account).



Do not install the unit outdoors or in places without proper ventilation. Before start-up, be sure the device reaches room temperature.

6.3 Storage

If the unit is to be stored for an extended period, protect it from moisture and dust.

6.4 Mounting instruction fastening set for wall mounting

Please check the included accessories:

Incl. in delivery item.-no. 174358 fastening set	
Quantity	Name
1	Securing bracket
1	Phillips head screw M 4x8
1	Washer Ø 4,3
1	Serrated washer Ø 4,3
1	Slotted screw 4 x 16
2	Slotted screw 6 x 50
2	Screw anchor S8
1	Screw anchor S5

Mounting instruction:

Please drill the holes as indicated in the following drilling template. Please make sure before that the wall is really suitable for mounting a device (aerated concrete walls and drywall are problematic).

Drilling template:

Bohrung=drilling
tief=deep

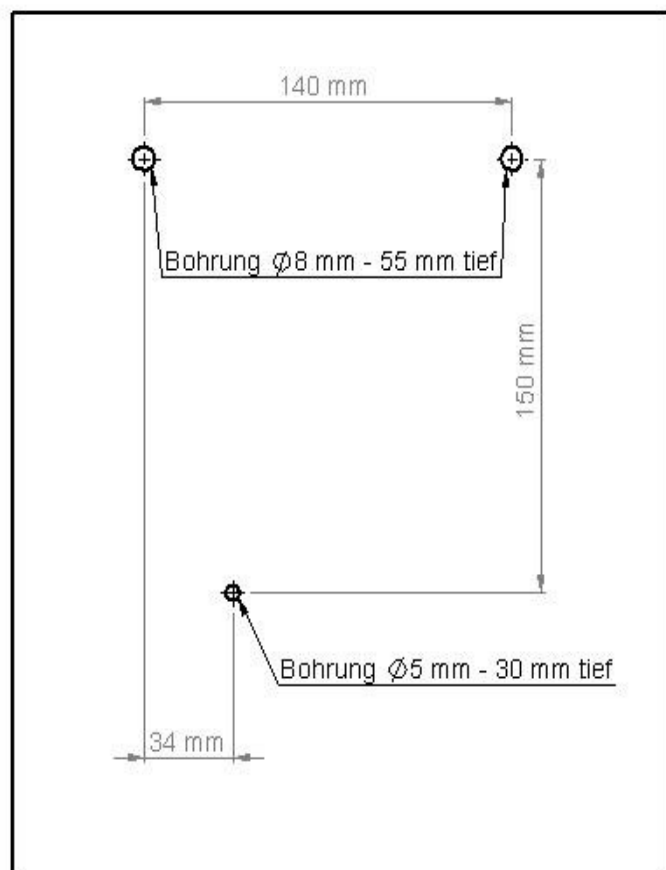

Secure the enclosed screw anchors as shown in Figure 1. Screw the 6x50 screws into the two upper holes; keep a distance of 6-7 mm to the wall! (Figure 2)

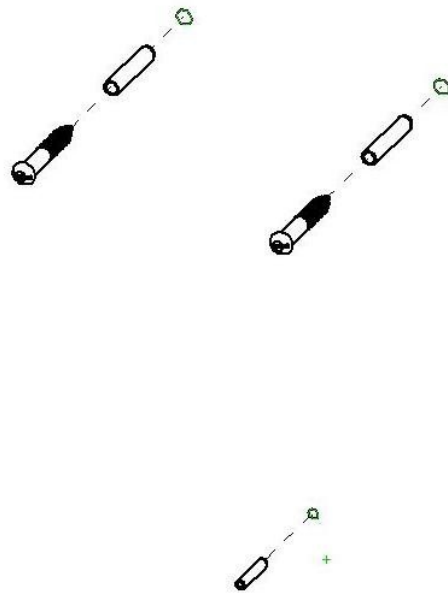

fig. 1

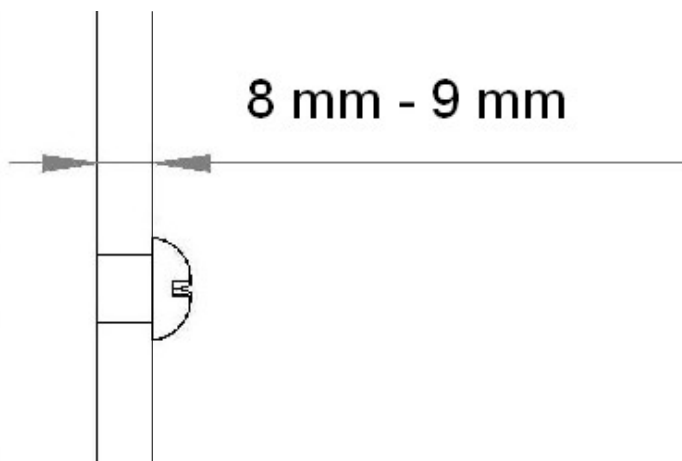
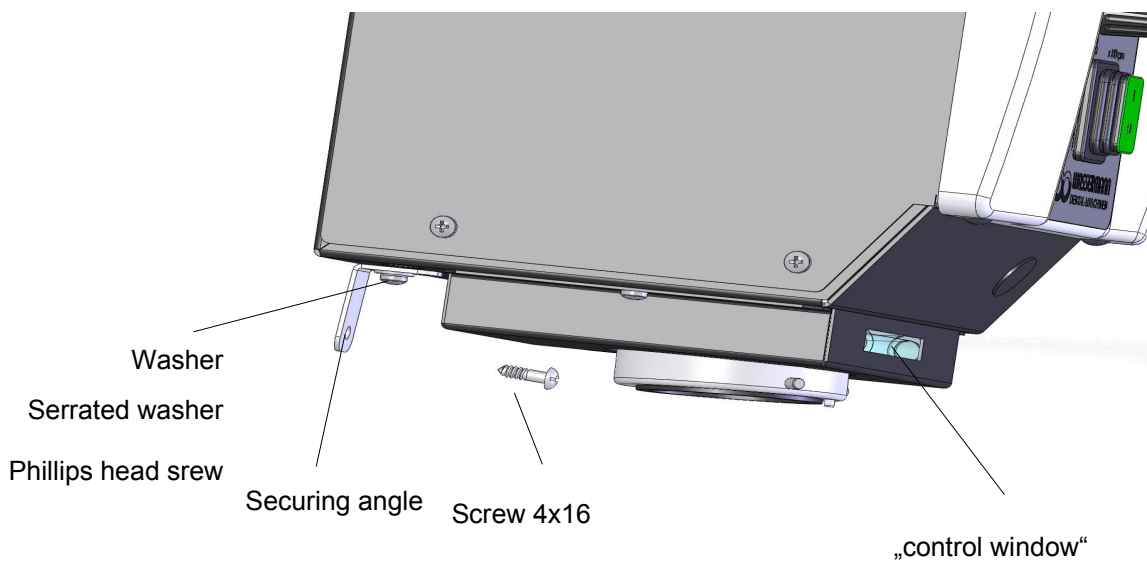

fig. 2

Screw the securing bracket to the Wamix as shown in Figure 3.

Do not yet fully tighten the Phillips head screw, however – you still need to be able to move the securing bracket.

fig.3



Carefully hook in the device. Check, whether the device hangs loosely (i.e. moving back and forth on the screws). If this is the case tighten the 6x50 screws until the device hangs securely. Finally tighten the securing bracket. First at the wall, then tighten the screw on the device itself (Figure 3).

7 Installation / Start-up



Before starting the unit, connect up the following:

Insert the power plug into the socket, making sure that the mains and the unit operate on the same voltage.

Start-up: Turn on the green switch (see (4) fig. 4).



Accidental mixing is not possible because the motor cannot start until the beaker is held to the rim by the vacuum. The mixing time also needs to be set.



Before you start your vacuum mixer, make sure that the safety hook has been fastened under the unit. Push the hook to the wall using the slot and fasten the safety hook to the wall. Than retighten the screw on the chassis to prevent it coming loose.



Warning: Use only beakers with the new curved seal (171708).



When using the 115 V version you have to install the power pack Order no. 171976. Therefore you plug in the conductor of the Wamix into the socket (Pos.1) of the power pack. The conductor of the power pack (Pos.2) has to be plugged into the house socket. In order to mount the power pack at the table stand please use the enclosed screws M6.

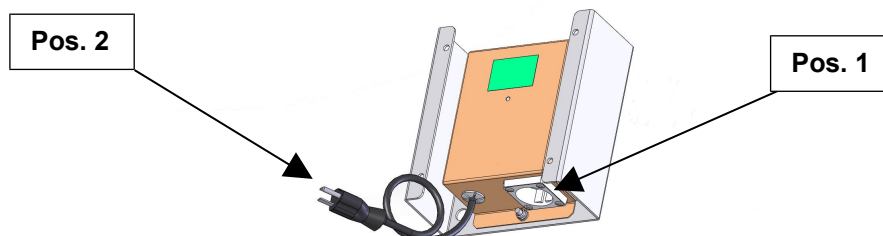

Switch the vacuum mixer off if the unit will not be used for an extended period.

8 Operation

8.1 General operating instructions

All instructions for using the unit, whether in verbal or written form, are based on our own experience and experimentation and can only be regarded as guidelines.

- i** Do not fill the beaker higher than to the *Max marking*.
Too much added material otherwise is taken up by the vacuum into the system. In the "control window" (Figure 3) the absorbed material is visible.
An early switching off the unit reduces the cost of repairs!

- i** The beaker will come away automatically once the vacuum is removed. To avoid damaging the seal, *never* remove the beaker by force.

- i** The sealing surfaces between the beaker and the plate have to be clean - likewise the rotor fastenings and the beaker lid - to ensure trouble-free operation.

8.1.1 Speed adjustment

This unit is equipped with a speed regulation of the agiator from 200 – 600 rpm.

A: automatic agiator-boost connection = adjusting knob (1) is between 200 min⁻¹ - 600 min⁻¹ findividually adjustable. The agiator starts automatically and immediatly when vacuum is sufficient (fig. 4)

B: manuel agiator-boost connection = adjusting knob (1) position „ 0 “. After the vacuum was built, set the adjusting knob (1) between 200 min⁻¹ - 600 min⁻¹ (fig. 4).

 Please do not use the speed „0“ longer than 240 sec.!

Fig. 4

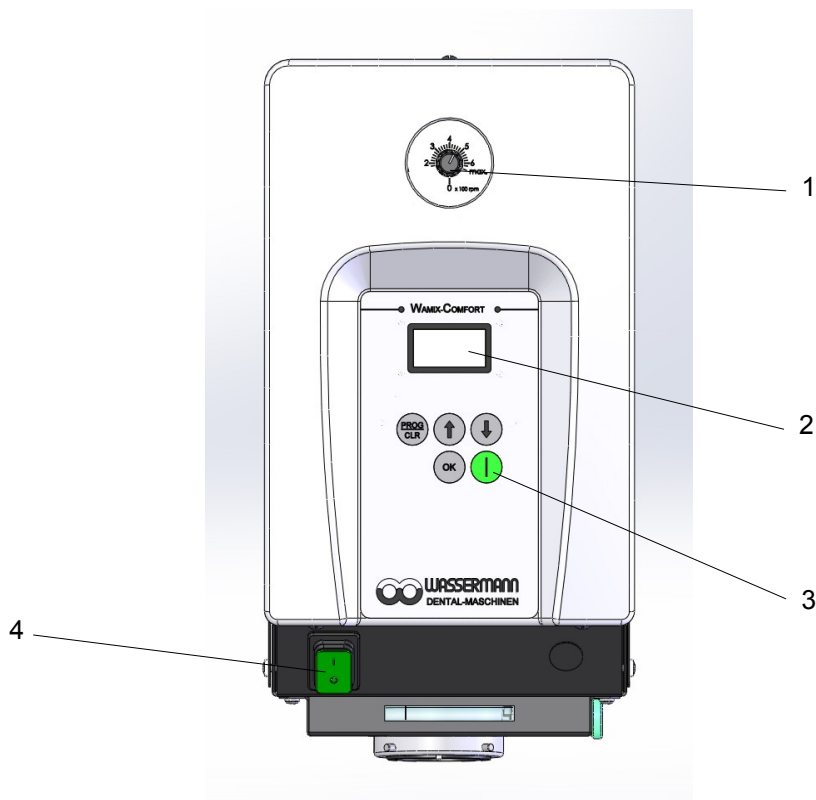

8.2 Operation / Programming Wamix-Comfort IV



After turning on the power

Display:



8.2.1 Starting the automatic program with vacuum

Display:



Press



Display:

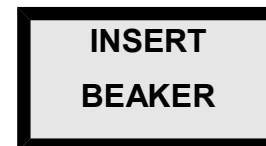

To start the program, insert the beaker in the flange from below. Hold the beaker until mixing starts.

Press



The program stops automatically.

Warning: Hold on to the beaker.

8.2.2 Changing from German to English

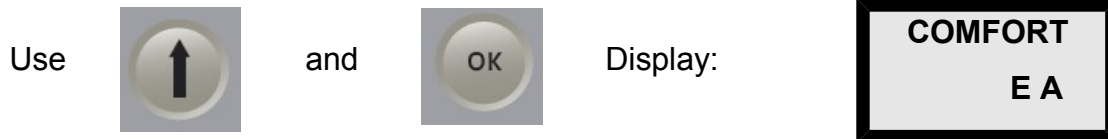

Press the buttons again to change back.

8.2.3 Programming

Up to 15 programs are possible using the following parameters.

- Program name: up to 8 characters
- Pre-vacuum: up to 99 seconds
- Mixing time: up to 240 seconds
- Post-vacuum: up to 99 seconds
- Times entered as a "0" will be ignored.

8.2.4 Sequence: (first time)

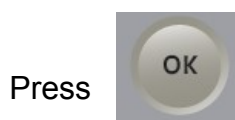
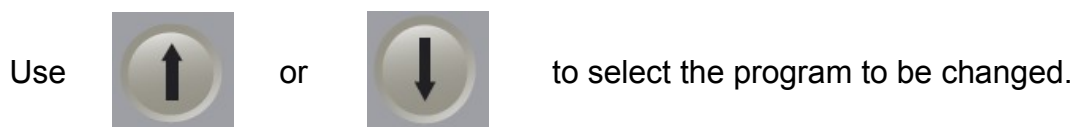
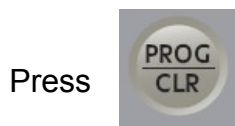

- Entering program name

Display:

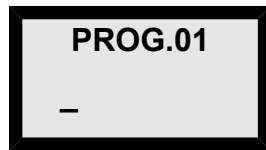

Select name with



or



Next name /



previous name.

Press

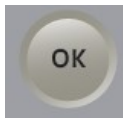

End of name entry.

- Entering pre-vacuum

Display:

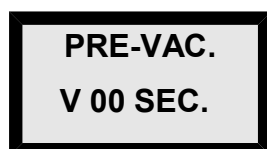

Select time with



or



Delete / zero value.

Press

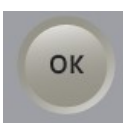

- Entering mixing time

Display:



Select time with



or



Delete / zero value.

Press

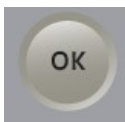

- Entering post-vacuum

Display:

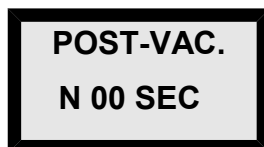

Select time with



or



Delete / zero value.

Press

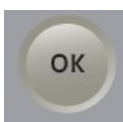

to store.

8.2.5 Starting program 01 (to 15)

Display: 

Press 

Display: 

Select the program with  or 

Press 

Display: 

To start the program, insert the beaker in the flange from below. The beaker must be held until the mixer stops.

Display: 

The individual program steps are carried out.

An audible signal indicates the end of the program.

Display: 

8.2.6 Changing between main and program menu

Display: 

Press 

Display: 

8.2.7 Interrupting program with START / STOP button

After you pressed **START / STOP**, the display reads "**INSERT BEAKER**". If the program is not to be completed for any reason, press **START / STOP** again to terminate it. Depending on whether the program was in automatic or manual mode, the display reads "**COMFORT D A**" or "**PROG. 01**", for example.

8.2.8 Changing the time during program operation

It is possible to change the time during program operation in *manual mode*.

Use  or  to extend or shorten the time.

This allows you to change the programmed times without interrupting the program.

9 Troubleshooting

Fault	Cause	Remedy
Mixer does not start	Blown fuse	Replace fuse and determine cause; otherwise, call Service Center
	No mixing time programmed	Set mixing time
	Adjusting knob is in position "0"	Adjust the speed
Vacuum too low	Filter (vacuum) blocked	Check filter – clean and/or change (see 8.2)
	Leaking seal on vacuum flange for mixing beaker	Replace seal
	Open valve	Turn valve on unit to the left.
No vacuum	Beaker filled above <i>Max</i> mark, i.e., mixing ingredients in system	Clean system, i.e., maintenance by Service Center
	Faulty vacuum pump	Maintenance by Service Center
	No vacuum programmed	Set vacuum to Full and confirm with OK
Beaker falls out	Faulty seal	Replace seal (171708)

i If the above recommendations do not solve the problem, contact your dental depot or our service department.

10 Care and maintenance

10.1 Cleaning



Disconnect the power plug before starting any maintenance work.

The identification plate has always to be kept in easily legible condition and has not to be removed.



Remove external dirt from time to time with some form of cold cleaner.

Use only cold cleaners to avoid damaging the paintwork or removing the lettering.

The equipment should be cleaned at regular intervals to ensure trouble-free operation. It requires only normal cleaning (sponge, damp cloth, mild detergent) and no further chemical additives.

Solvents **must not** be used to clean the front panel!

Keep the beaker clean. When not in use, fill with water to just below the mixer.



Cleaning mixing beakers in an ultrasonic bath, especially if plaster solvents are also used in the beaker, will inevitably result in changes to the structure of the beaker material and will therefore damage the mixing beaker.

10.2 Maintenance

i Allow the condensers to discharge *before* you open the mixer.

Our vacuum mixers do not require servicing. Make sure the unit is kept clean and that the rim seal for the beaker (vacuum seal) is not damaged.

10.2.1 Changing the filter

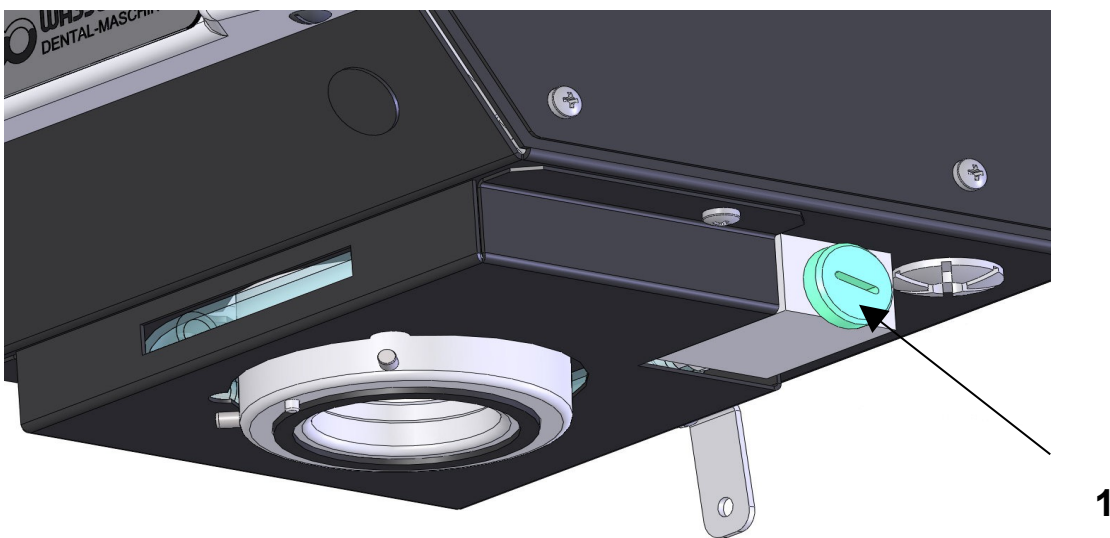

Remove screw (1) (on the left, near the mixer mechanism on the rim under the unit). The filter swings loose at the forward end of the screw. After changing the filter, do up the screw *finger-tight* (do not forget the O-ring).

10.3 Warranty

i The warranty period for our equipment is 12 months. If faults occur within the warranty period, contact your dental depot or get in touch directly with our service department.

Your equipment should only be operated in perfect condition. If faults occur which could harm operators or third parties, the unit should not be used until it has been fixed.

This warranty does not cover damage caused by improper use, external mechanical causes, transport damage or interference with the unit by unauthorized persons.

10.4 Spare Parts

If necessary please contact our service hotline phone.

10.5 Service Hotline 0049 (0)40 730 926 -20/ -24

10.6 Scope of delivery/ Accessories

Included in delivery	Item no.:
Beaker medium cpl. 350 ml	171283
Mounting set	171290

Accessories	Item no.:
Table stand (W 219 x H 467 x D 308 mm)	171760
Beaker extra small cpl. 75 ml	171295
Beaker small cpl. 200 ml	171230
Beaker medium cpl. 350 ml	171283
Beaker large cpl. 600 ml	171237
Beaker extra large cpl. 1000 ml	171269
Vacuum washing beaker 600 ml	171275

10.7 Repairs



Servicing or repairs to the unit has only to be carried out by qualified technicians. Only original spare parts are to be used. Responsibility for the product is voided if unauthorised persons alter it or if inappropriate components are installed.

11 Technical data

Wamix-Comfort IV	Item no.: 171977
Voltage (other voltages on request)	220–240 V / 50/60 Hz
Power consumption	2,9 A (Si 40 A)
Output	315 W
W x H x D incl. wall mount	205 x 370 x 245 mm
Weight	9,9 kg
Speed	200–600 min ⁻¹
Vacuum	approx. 900 mbar
Mixing time	Up to 240 seconds adjustable
Safety class	IP 22

The noise level of the unit amounts to ≤ 70 dB(A).



The technical data are subject to change without prior notice.

12 Disposing of the unit

The unit has to be disposed by an authorized recycling operation. The selected company has to be informed of all possibly health-hazardous residues in the unit.

12.1 Information on disposal for countries within the EU



To conserve and protect the environment, prevent environmental pollution and improve the recycling of raw materials, the European Commission adopted a directive that requires the manufacturer to accept the return of electrical and electronic units for proper disposal or recycling.

Within the European Union units with this symbol should not therefore be disposed of in unsorted domestic waste.

For more information regarding proper disposal please apply at your local authorities.

13 EU Declaration of Conformity

in accordance with 2014/35/EU (Low Voltage Directive) and 2014/30/EU (Electromagnetic Compatibility Directive) and 2006/42/EC (Machinery Directive) and 2011/65/EU (RoHS Directive)

Manufacturer: **W A S S E R M A N N** Product description: Vacuum Mixer for dental applications
Dental-Maschinen GmbH
Rudorffweg 15-17
21031 Hamburg
Germany

Model: Wamix-Comfort IV Item no. 171977

Applicable standards: DIN EN 61010-1
DIN EN 61000-6-3
DIN EN 61000-6-1
DIN 45635-1
DIN EN 60335-1

Hiermit wird bestätigt, dass die oben bezeichnete Maschine den genannten EG-Richtlinien entspricht. Diese Erklärung wird ungültig, falls die Maschine ohne unsere Zustimmung verändert wird.

This is to confirm that the above mentioned machine complies with the described EC rules. This declaration becomes invalid if the machine is modified without our approval.

Cette machine est conforme aux normes en vigueur de la Communauté Européene. Cet avis est nul et non avenant si cette machine est modifiée sans notre accord.

Esta máquina, anteriormente mencionada, cumple con los límites requeridos por el reglamento EC. Ahora bien, esta declaración quedará invalidada en caso de realizar modificaciones al aparato sin nuestra aprobación.

Hiermee wordt bevestigd dat bovengenoemde machine voldoet aan de voorgeschreven EU normen. Deze verklaring verliest geldigheid als er zonder onze uitdrukkelijke toestemming wijzigingen aan de machine worden aangebracht.

Place, date: Hamburg, 2017-07-13

Company stamp:



Signature : 
Wilfried Wassermann
(Managing Director)

Notes:



Wassermann Dental-Maschinen GmbH
Rudorffweg 15-17 · 21031 Hamburg · Germany
Phone: +49 (0)40 730 926-0 · Fax: +49 (0)40 730 37 24
info@wassermann-dental.com · www.wassermann.hamburg