

Boil Out Unit
Wapo-Ex 12 II



USER MANUAL

Dear customer,

Thank you for choosing a product from the Wassermann range. Wassermann Dental-Maschinen incorporates the highest standards of quality and the latest technology. In order to enjoy maximum performance and years of trouble-free operation, please read this user manual carefully before you connect this device and start work, and operate the device according to the recommended guidelines. The operation safety and the functionality of this device can only be guaranteed if you follow both the general safety guidelines and the applying laws to prevent accidents as well as the precautions given in this user manual. We are not liable for any damages which occur due to inappropriate usage or faulty operation of this device.



Make sure that anyone using this device has read and understood this user manual.

Keep this user manual in a safe place where it can be referred to as required at any time.



The unit complies with the relevant EU guidelines.



The unit is subject to the EU guidelines 2012/19/EU (WEEE Directive).

Company address:

Wassermann Dental-Maschinen GmbH

Rudorffweg 15-17

21031 Hamburg, Germany

Phone : +49 (0)40 730 926 -20/ -24 Fax.: +49 (0)40 730 37 24

export@wassermann-dental.com

www.wassermann.hamburg

www.facebook.com/WassermannDentalmaschinen

Contents

1 Features.....	4
2 Safety Symbols used in this Manual.....	5
3 Safety Guidelines.....	5
4 Responsibility for Operation or Damage.....	6
5 Application.....	6
6 Before Starting.....	6
6.1 Transport.....	6
6.2 Installation.....	7
6.3 Storage.....	7
7 Installation/ Start-up/ Menu Functions.....	8
7.1 Water Supply.....	8
7.2 Fitting the Spray Gallows.....	8
7.3 Preparation.....	9
7.4 Start-up.....	10
7.4.1 The Selector Lever.....	10
8 Operation.....	23
8.1 General Operating Instructions.....	23
8.2 Operation.....	24
8.3 Manual Spray Head.....	24
9 Troubleshooting.....	25
10 Care and Maintenance.....	27
10.1 Cleaning.....	27
10.1.1 Cleaning the Wax Container.....	28
10.1.2 Changing the Water.....	28
10.1.3 Cleaning Procedure of the Combi Sensor v.2.....	29
10.1.4 Dismount and Cleaning of the Combi Sensor v.2.....	30
10.1.5 Lime Removal.....	32
10.2 Maintenance.....	32
10.3 Repairs.....	32
10.4 Spare Parts.....	32
10.5 Service Hotline 0049 (0)40 730 926 -20/ -24.....	32
10.6 Scope of Delivery/ Accessories.....	33
10.7 Warranty.....	33
11 Technical Data.....	34
12 Disposing of the Unit.....	34
12.1 Information on Disposal for Countries within the EU.....	34
13 EU Declaration of Conformity.....	35

1 Features

The **Wapo-Ex 12 II** combines all-round skill, years of experience and the latest technology to produce an outstanding product. This well-designed free standing unit with integrated spray gallows scalds up to 12 flask halves simultaneously and fully automatically. The innovative multifunction touch-screen terminal offers diverse functions and reproducible procedures by simple programming. The Wapo-Ex 12 II is very durable and stands out thanks to its flexible usage, programmable timer and automatic wax removal. The electronic water level gauge, the leakage signal and the inlet limitation ensure additional safety.

- Free standing unit for scalding up to 12 flask halves or 8 IVOCAP flask halves
- Multifunction touch-screen terminal for easiest operation
- Efficient usage thanks to its programmable timer and automatic wax removal
- Stainless steel construction
- Safety features with visual and audible signals
- Easy to clean and easy to operate
- Very durable and energy saving because of the intelligent heating control and the high quality insulation

2 Safety Symbols used in this Manual



Warning!

This is a warning of risk situations and dangers.

Failure to observe this warning could be life-threatening. These warnings has to be observed.



Information!

This symbol draws your attention to specific features that has to be observed.

3 Safety Guidelines

Configuring and operating this equipment requires ***precise knowledge*** and ***observance*** of the instructions in this ***user manual***. The equipment is designed only for its intended application.



WARNING:

Service and repairs should be carried out only by authorized specialists.

Disconnect the power plug before starting any maintenance work.



Make sure that the equipment is connected to the correct power source.



Use heat-resistant gloves when working with the Wapo-Ex 12 II.



Risk of scalding!

Do not hold the manual spray head by the rose or hose.

Do not direct the spray at other people.

Water coming from the spray head can be at temperatures up to 95°C; only direct the head towards the cover area or washbasin.

4 Responsibility for Operation or Damage

The responsibility for operating the device lies exclusively with the owner or user if said device is incorrectly serviced, maintained or altered by persons not employed by an authorised dealer or if the device is used in a manner contrary to its specified purpose. The unit has to be maintained and operated in accordance with this user manual. Wassermann Dental-Maschinen GmbH is not responsible for damage arising from the **nonobservance** of these instructions.

Warranty and responsibility provisions contained in the sales and supply conditions of Wassermann Dental-Maschinen GmbH are not extended by these instructions.

5 Application

The **Wapo-Ex 12 II** is suitable for scalding wax for up to 12 flask halves and also for scalding smaller parts in the deeper cover by using the manual spray head.

Only use the device for this type of application.

6 Before Starting

6.1 Transport

Before transporting the unit, ensure that it has been unplugged from the power socket. Make sure that it is packed correctly in order to avoid accidental damage.



Be sure to check for any transport damage when unpacking the goods. Note down any damage if found.

6.2 Installation

Open the box, remove the packing materials, and carefully lift out the device and accessories. Check the included accessories.

The device has to stand horizontally on a steady and even surface. Set the unit up close to a water supply tap with $\frac{3}{4}$ " external thread and a water drain.



Install the device in a place where it will not block the working area and the functionality (take the dimensions into account):

- Height with spray gallows: 1600 mm
- Width included side wall distance (right): 700 mm
- Depth included wall distance (rearwards): 670 mm
- Make sure the water drain level is above 470 mm
- Leave a side clearance of at least 50 mm at the right and the rear side of the unit to allow adequate heat circulation.



Tip: Install the unit under an extractor hood to remove the steam.
It has to be fitted with a fuse (16 A / 230 V).



Do not install the unit outdoors or in places without proper ventilation.
Before start-up, be sure the device reaches room temperature.

6.3 Storage

If the unit is to be stored for an extended period, protect it from moisture and dust.

The unit location is very important when it comes to workplace safety, even if it is only to be set up there for a short period. The room should be dry, well ventilated and vibration-free. An even temperature and wooden supports also help.

The unit should not be stored or set up outdoors.

7 Installation/ Start-up/ Menu Functions



Before starting the unit, connect up the following:

7.1 Water Supply

- Insert the supplied feeder hose gasket in its seat.
- Connect the hose to the tap.
- Connect the drain hose with the help of a hose clamp to the outlet on the unit.
- Make sure the hose is at a suitable height above the feeder pipe.



The minimum amount of water should be about 4,5 l/min at a supply pressure of 1,5- max. 6 bar.

7.2 Fitting the Spray Gallows

- Raise the coil until the screw fitting can be seen.



In order to avoid injury, be sure to take hold of the spacer to raise the coil.

- Angle the head over the spray area and screw in the gallows.

7.3 Preparation

As well as connecting the unit correctly, the following tasks need to be carried out before you start-up:

- Remove both sliding covers;
- Remove the flask baskets, fence for small parts and scalding channel;
- Swing the spray arm up and remove;
- Remove the large, loose stainless steel basket;
- Check that the pump filter is sitting correctly in place;
- Remove remaining packaging;
- Insert roller in bearing.

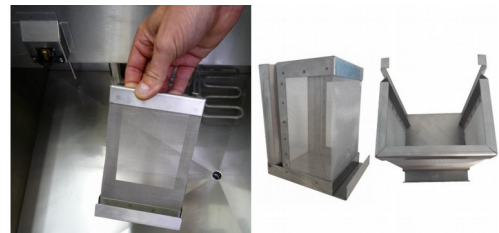

Fig.: Pump filter



The roller carrier can only be inserted vertically in the vertical holder for the drive shaft.

- Reinsert the large stainless steel basket;
- Fit fence for small parts in the large stainless steel basket.
- Fit the spray arm on the connecting joint and swing it down (bayonet connector).
Make sure all seals are clean.
- Insert the channel from the front so that any small particles can be caught in the mesh of the large stainless steel basket.
- Swing the handle in again when reinserting the flask holders.
- Fit sliding cover and close (turn through 180°).
- Remove cover (magnetic mount on front of unit) and close drain tap (lever horizontal). Insert the waste container under the drain tap. Replace cover.
- Open tap and check feeder hose for leaks.



The unit can be emptied using a siphon; make sure the drain hose does not leak and is firmly attached to prevent it coming loose. If there is no waste drain, hang the hose in a washbasin.

7.4 Start-up



Prior to initial operation, attach and check the feeder and drain hoses!

Firmly clamp the supplied drainage hose to the device and ensure there is a suitable drainage facility.

7.4.1 The Selector Lever

The following functions can be set using the selector lever:

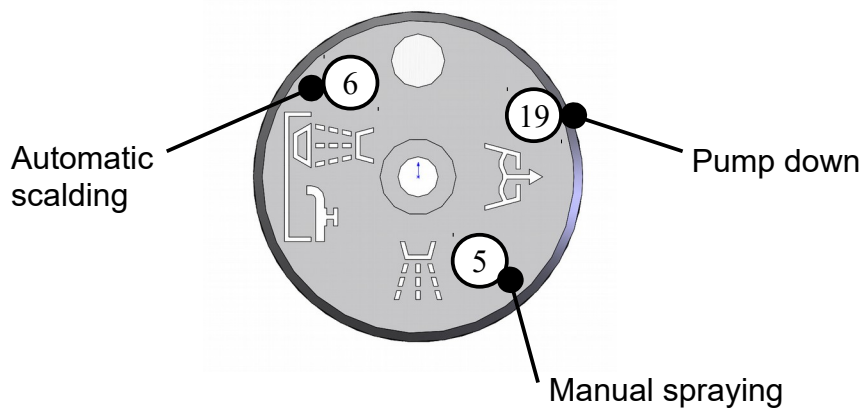

Pull up the selector lever to unlock.

Insert the power plug into the socket, making sure that the mains and the unit operate on the same voltage. Turn on the main switch (green rocker switch). Set the selector lever to the "Automatic scalding" position .

Touch on  and water supply is activated or if already activated before (please see point (18)) the machine fills up automatically. Please note the safety function, if necessary, pull the lever up to unlock.





After switching on the unit without automatic water supply the display shows:



After switching on the unit with automatic water supply the display shows:



Water fills the container to the working level and is heated to the operating temperature automatically (approximately 1.5 hours). The default setting for this is **85 °C/185 °F**. Add wax remover once the operating temperature (nominal temperature display 85 °C) has been reached. Use the manual spray to do this.

- Add 100 ml wax remover (without solvent) to the scalding channel.
- Set the selector lever to  position. Follow unlocking procedure.
- Tap the  symbol on the display. The process must be ended manually. Stop the process by pressing the  symbol again.
- Set the selector lever back to  "Automatic scalding" again.

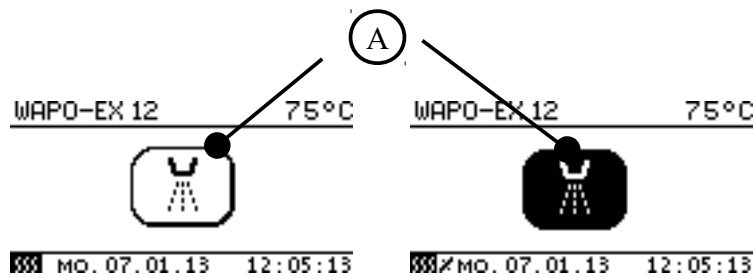

 **Wax remover only needs to be added as described above if the water is changed or water is lost (depends on work load).**



The following safety instructions have to be followed for safe work with the manual spray:

- Adjust the spray so that the spray holes are directed towards the channels.
- Do not hold the manual spray head by the rose or hose.
- Do not direct the spray at other people.
- We recommend the use of gloves because of the high temperatures (up to 95°C) involved.

Define the unit's main parameters before switching it on. These settings are performed in the **set-up menu** (3). Familiarize yourself with the system's various options before starting the scalding process. This particularly applies to functions (7) and (14).

The start menu

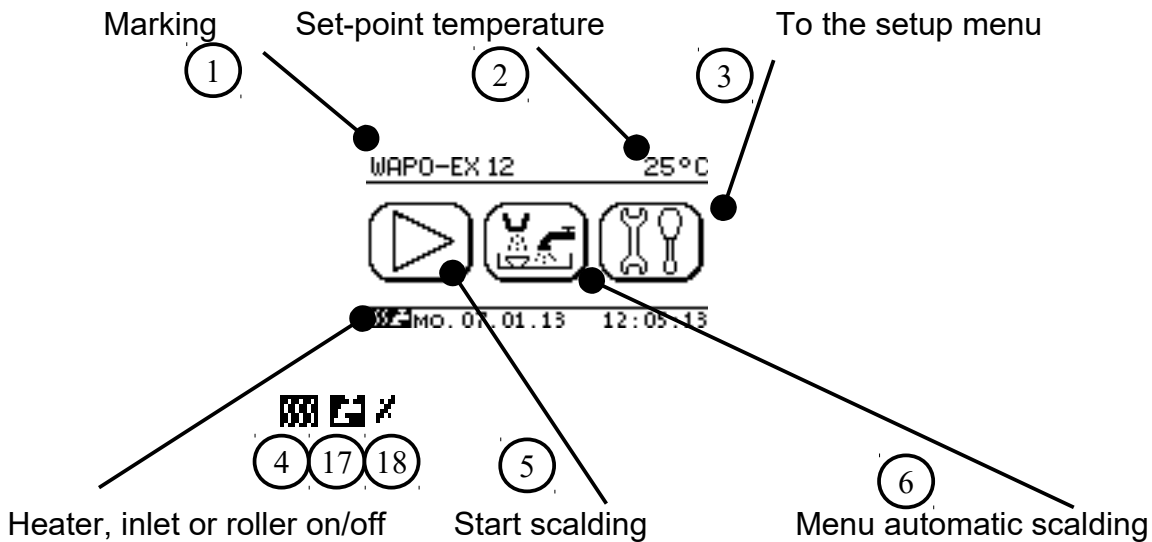

Set-up menu page 1

In the set-up menu adjustments are possible as follows:

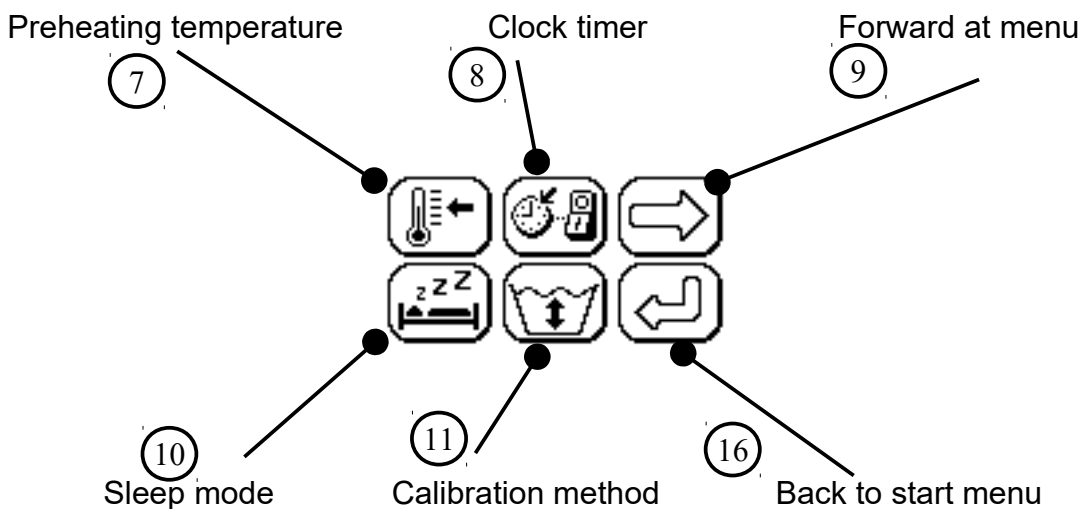

Set-up menu page 2

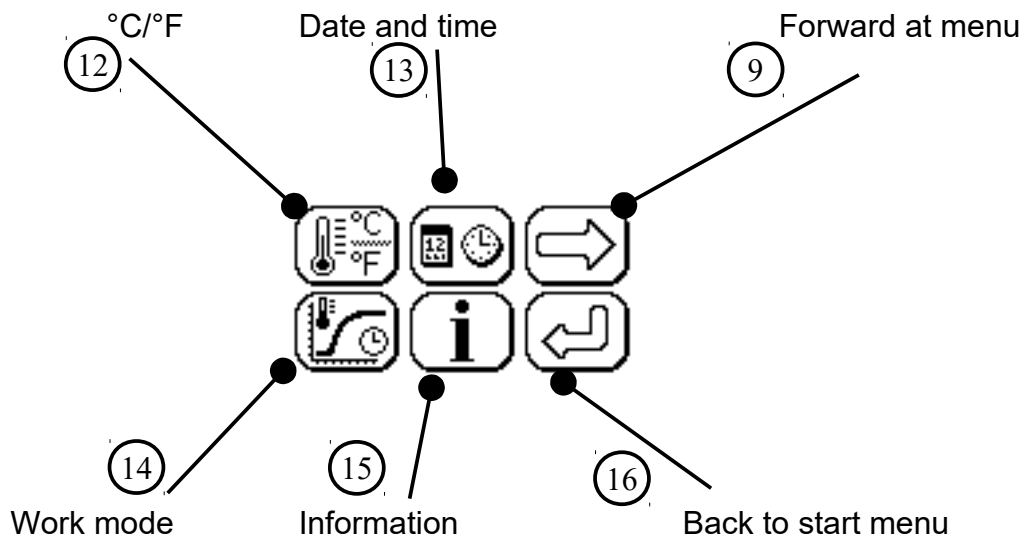

Set-up menu page 3

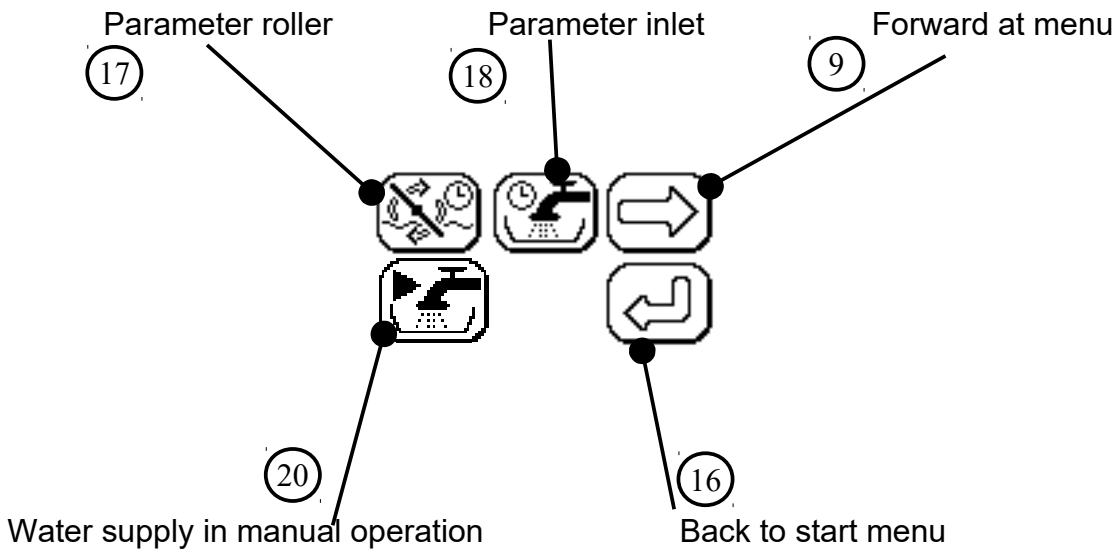

Specification of the operation 5 – 19

5 Menu manual spray head

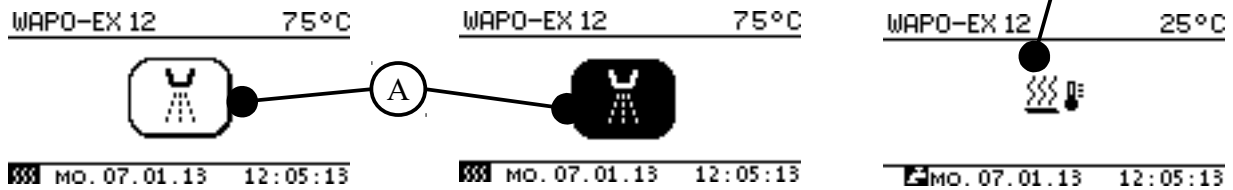

The manual spray process is started by pressing the (A) symbol. The symbol is inverted. The process is stopped by pressing the inverted (A) symbol.

i This function is available from 66 °C. If the temperature falls below 66 °C the process is canceled and the heating symbol (B) appears.

6 Menu automatic scalding

Define the parameters for scalding temperature and scalding duration. By briefly tapping the numbers, the parameter selected is expanded and the values can then be changed.



Touch the arrow (**Start**) to start the program. Interrupt or cancel the program by pressing the "**Stop/Pause**" symbol.

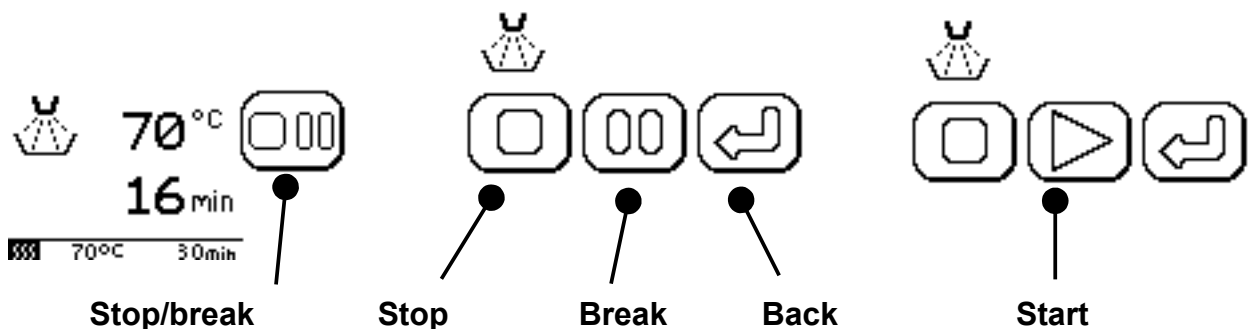

7 Preheating temperature / Standby temperature

Defines the target temperature once the main switch has been activated. The pre-heat temperature also applies to waiting times and rest periods. Default: **85 °C**

 If the program temperature selected is higher, the temperature reverts back to this value when the program ends.



After defining the desired working mode (14), it may make sense to adjust the pre-heat temperature of the program temperature. This avoids long heat-up or cool-down phases. The pre-heat temperature may be up to 8 °C higher than the program temperature for the program to start. The control system will then adjust (reduce) the temperature to the programmed value.

8 Clock timer

This defines the weekday activation and deactivation times.

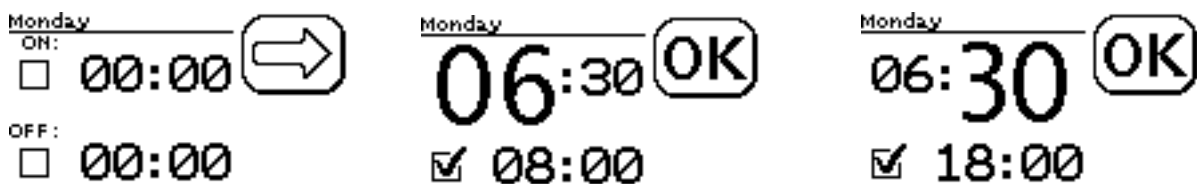

Ongoing programs have a higher priority; they are not switched off until complete.

9 "Forward in menu"

10 Display of the sleep mode

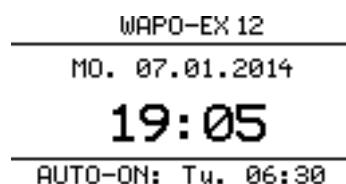

By touching the sleep symbol the unit changes into the sleep mode.

11 **Definition of calibration method**

Only necessary for start-up with deviating water quality!



This calibration [CAL] is only required if your Wapo-Ex 12 II boil out unit does not correctly detect the water level.

Important information: At first check and clean the combi sensor v.2!



DEF: Default (standard factory setting, calibrated for mains water)

CAL Calibration (only necessary for extreme deviations in water quality)



This ensures temperature sensors are adjusted to the conductance of the water. How it works: Pump out water. The water level drops to below the sensor. Evaluate temperature sensors values. Water fills until the upper sensor is well covered by water. Evaluate temperature sensors values. Should there not be sufficient time to fill with water, then please manually fill with water until the upper sensor is covered.

Ensure that the water level is close to the upper sensor (page 24: Figure below). Turn the selector lever to the pump position (19) . The calibration process will now start automatically. Please confirm the calibration with OK (images below are just similar).

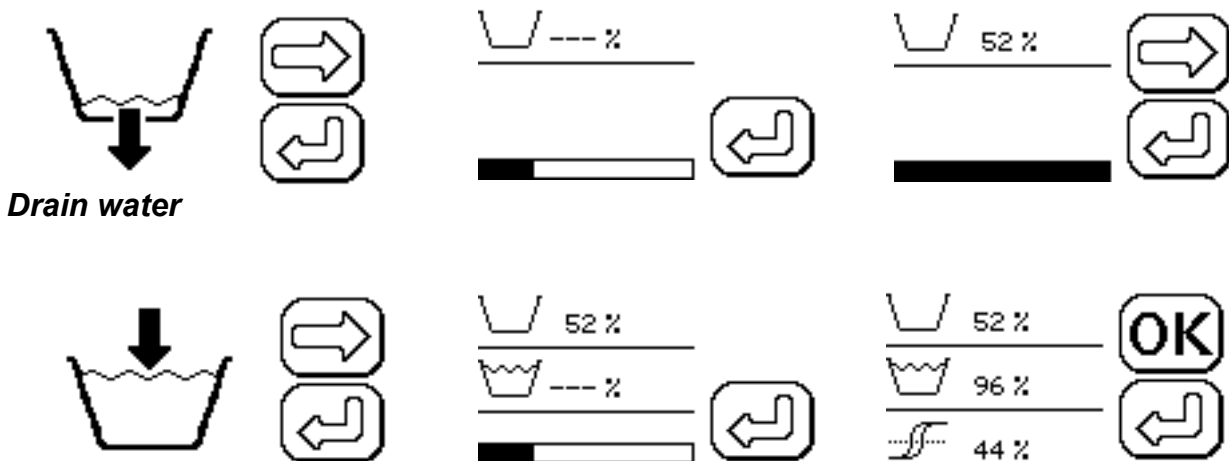

Fill water

12 Selection of temperature (Fahrenheit or Celsius)

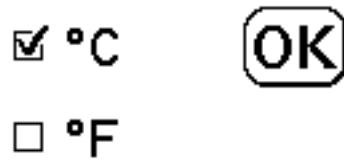

13 Pictogram for the time and date function cycle

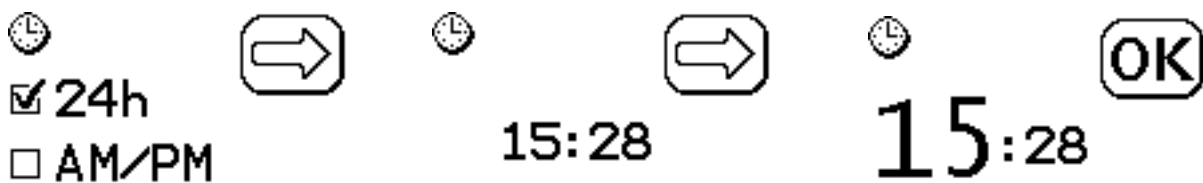

14 Selection of work mode

Defines whether the scalding time should start immediately or only after the heating value has been reached.

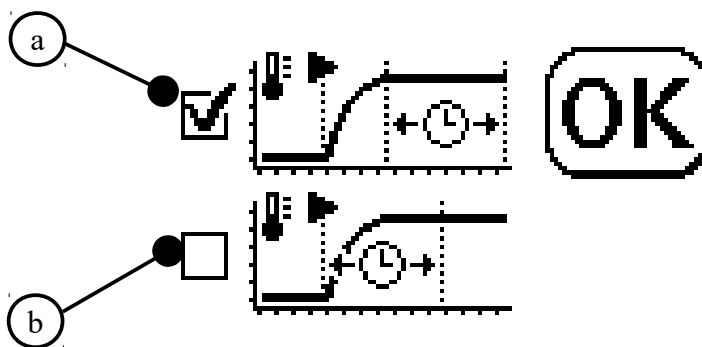

(a) Unit heats up to the temperature programmed under 6 plus tolerance to compensate for heat loss through the conveying pump. After reaching this value, the result measured is validated by a control cycle. If the value is confirmed, the scalding process will start.

(b) (default) The scalding process programmed begins immediately but not before reaching 66 °C Celsius. Please select a suitable pre-set temperature 7.



Please note that, owing to the scalding process, the temperature can fall by several degrees. The higher the set temperature, the higher the deviation.

15

Information

Here the parameters from the touch screen, sensors, hardware and software are displayed.

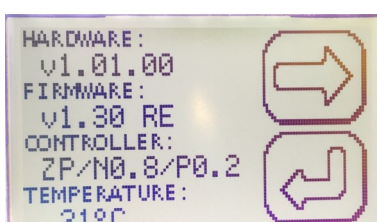
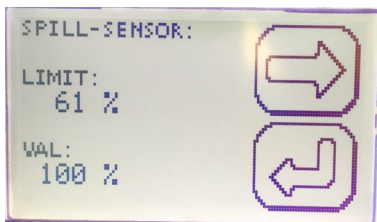
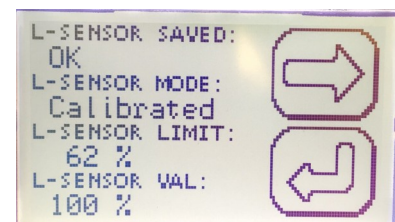
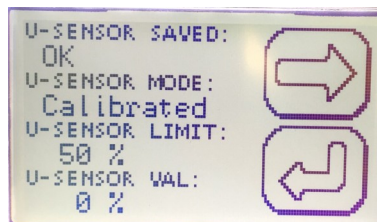
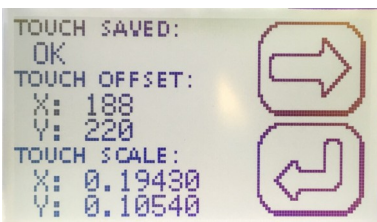

16

„Back to start menu“

17

Automatic wax removal

The automatic wax removal process is conducted before or after the scalding process once a minimum temperature of **80 °C** has been reached. The removal/rolling mode is indicated by the symbol or if it is active. Parameters for rolling control.



(a) Default: 3 min **ON** / 3 min **OFF**.

(b) Manuel: 1-29 min **ON** / time-off = time-on.

18 **Automatic water supply**

The automatic water supply is different in program flow than in the stand-by mode.

- During waxscalding the function „Filling during waxscalding“ decides about refilling.
- During the stand-by mode the function „Filling at Power-On“ decides about the water supply with or without asking the user in advance.

After a water supply malfunction  „Filling at Power-On“ is OFF (inactive).
The hold-up has to be unblocked by OK. If necessary please match the parameters.

Then the water supply runs for 10 seconds when the temperature is less than **83°C**.
If the temperature is higher than **83°C** the water supply runs until reaching the upper sensor. There are two further parameters: „Filling at Program End“ (water supply when program ends) and „Filling before entering Sleep“ (water supply before entering sleep).
These parameters regulate if water supply should run to these points in time.
For that function the temperature has to be higher than **83°C**. If the temperature is lower there will be no water supply.

Function: Filling at Power-On

- Standby-refilling without asking.
- This parameter will be set OFF after a malfunction.

Filling at
Power-On
 ON



OFF



Default: ON

Function: Filling at Program end

- Allows refilling after waxscalding.

Filling at
Program end
 ON



OFF



Default: ON

Function: Filling before entering sleep

- Allows refilling before entering sleep.

Filling before
entering Sleep
 ON



OFF



Default: ON

Function: Filling during waxscalding

- Allows refilling during waxscalding.

(Use only when the unit is connected to a hot water tap)

Filling during
waxscalding
 ON



OFF



Default: OFF

Filling time limit

The inlet can be done in adjustable intervals or constant. The programming can happen through variable times of inlet, interval times and the total time of all inlet times.

The activated water supply can be recognized through the symbol .

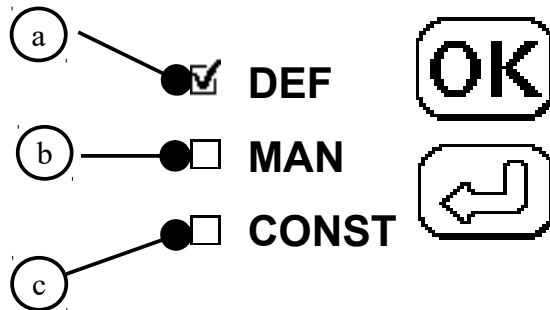



(a) Default: 30s **ON** / 90s **OFF** / 120s = sum of all ON times

(b) Manually: 10s-59s **ON** / 0s-199s **OFF** / 10s-199s = sum of all ON times

(c) Constant: constant water supply of 10s-199s adjustable

Factory setting: DEF



In order to be on the save side we have programed 60 seconds of water supply from the lower sensor to the upper sensor. Please conform this time to the real time under the parameter **CONST** or **MAN**.

If time is set to short  appears on the display. After switching on  appears and the parameter „Filling at Power-On“ will be set OFF. Than please push the button to match the parameter if necessary. Change the parameter „Filling time limit “.

19 Pump down / drain

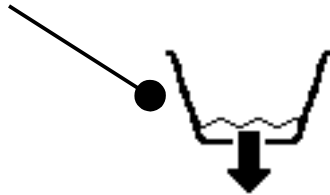
Unlock the selector lever by pulling up and moving the selector lever to the pump out symbol.



Now this symbol  appears on the display. Tap to now start or interrupt the pumping process. End the process as soon as the container is empty. The next water supply has to be confirmed by tap the symbol .



Operating the pump without water may cause the pump to fail.

Turn off the pump when it is air suctioning.

Remove the residual water with the valve on the bottom of the basin.

Draining the system is only possible when the unit is **heat up to 65°C** at least.

20 Water supply in manual operation

The mode of operation is similar to the automatic water supply  This function is activated if the water temperature is more than **83°C**.

8 Operation

8.1 General Operating Instructions

All instructions for using the unit, whether in verbal or written form, are based on our own experience and experimentation and can only be regarded as guidelines.



The Wapo-Ex 12 II is protected against running dry if the water is too low. A warning signal also sounds if the water level is too low. An additional safeguard protects the heater against overheating; it is automatically deactivated at temperatures above 97 °C.







Remove the power plug if the unit is not to be used for a long period.



Use a touch pen to prolong the life of the screen protector.

8.2 Operation

- Switch on the main switch (green rocker switch).
- The water supply takes place if the automatic water supply is activated. Otherwise press  to activate the water supply .
- Place prepared cuvettes into the unit's clamp.
- Unlock the selector lever and set to automatic for automatic scalding.
- Automatic scalding (temperature/time) is started by the  (C) or  (D) symbol. After the scalding process has ended, the temperature falls/rises to the pre-set temperature (7) again.

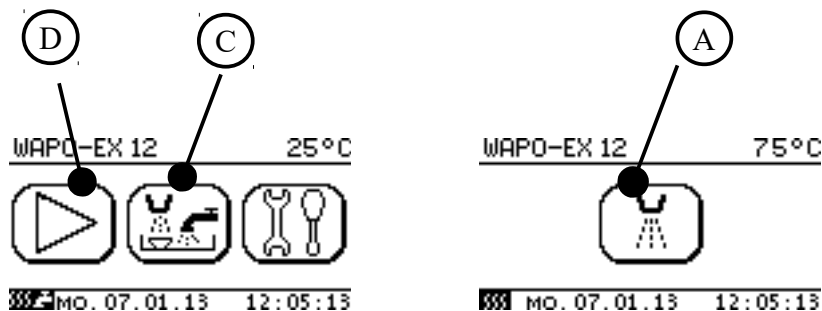

8.3 Manual Spray Head

- To manually scald using the spray, the selector lever must be set to the  position. Follow unlocking procedure. Then, tap the (A) symbol on the display to start the process. The process must be ended by manually tapping the inverted (A) symbol.

In its ready state (> 66 °C), the manual spray can be activated at any time by moving the selector lever. Please pay attention to the warning signs.





The Wapo Ex-12 (II) is only ready for operation at temperatures above 66 °C, i.e. the pump only starts working after the set temperature has been reached. An additional safeguard protects the heater from overheating; it is automatically deactivated at temperatures above 97 °C.

9 Troubleshooting

After a sensor warning the automatic refilling is disabled, but the heating and the brush-cycle not. Just if there is no confirmation during 10 hours, the unit stops all functions for safety reasons and than needs a reboot.

This is a new function since version V0143.

Fault	Cause	Solution
Wapo-Ex 12 II does not heat	Combi sensor v.2 is dirty	Clean the combi sensor v.2
Wapo-Ex 12 II does not heat although water level is ok and combi sensor is ok	Start-up with deviating water quality	Please contact our service. If a calibration is necessary please see page 16
Symbol „lid is open“ 	Sliding lid is open	Close sliding lid
Warning Timeout <small>TIMEOUT WARNING</small> 	Filling time limit is over. Upper sensor is dirty	Clean the combi sensor v.2. Dismount the combi sensor v.2 (see 8.1.1) and clean it with hot steam, if it is very dirty. Check the parameter „Filling at Power On“. Ensure water supply. Time of inlet to short change as described in point 18. Check the parameter „Filling at Power On“.



Fault	Cause	Solution
<p>Level Warning</p> <p>The display shows:</p>  <p>an the heating shutdown takes place.</p>	<p>Water level is too low</p>	<p>Press the „OK“ button to confirm the level warning.</p> <p>Warning: if there is no confirmation during 10 hours, the unit stops all functions.</p> <p>After the confirmation the display shows:</p>  <p>Touch on  at last.</p>
<p>Touchscreen malfunction</p>	<p>Calibrate the touch display</p>	<p>Switch on the unit. <u>While</u> the logo of Wassermann appears please contact the touch display two times. Then you will reach the self-explanatory touch panel-calibration (Fig. 1-2).</p>
	<p>Screen protector damaged?</p>	<p>Please contact our service.</p>
<p>Waxscalding doesn't start immediately although the set temperature is reached.</p>	<p>In work mode (a) willfully the temperature is 1° overheated and the program waits two minutes to validate the values.</p>	<p>This is not an error. Please wait approx. 3 minutes.</p>



Figure 1

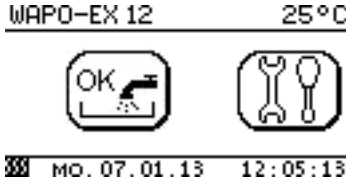
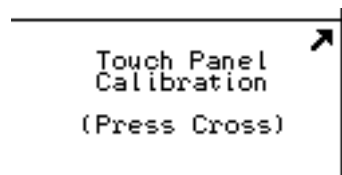

Figure 2



If the above recommendations do not solve the problem, contact your dental depot or our service department.

10 Care and Maintenance

10.1 Cleaning



Disconnect the power plug before starting any maintenance work.

The identification plate has always to be kept in easily legible condition and has not to be removed.



Remove external dirt from time to time with some form of cold cleaner.

Use only cold cleaners to avoid damaging the paintwork or removing the lettering.

The unit should be cleaned at regular intervals to ensure trouble-free operation.

Clean the outside of the unit with a sponge or soft cloth and mild detergent.

The WAPO-Ex 12 II with the combi sensor v.2 comes with an internal cleaning nozzle for the sensor. For cleaning the sensor, please follow the steps of these instruction on page 29.

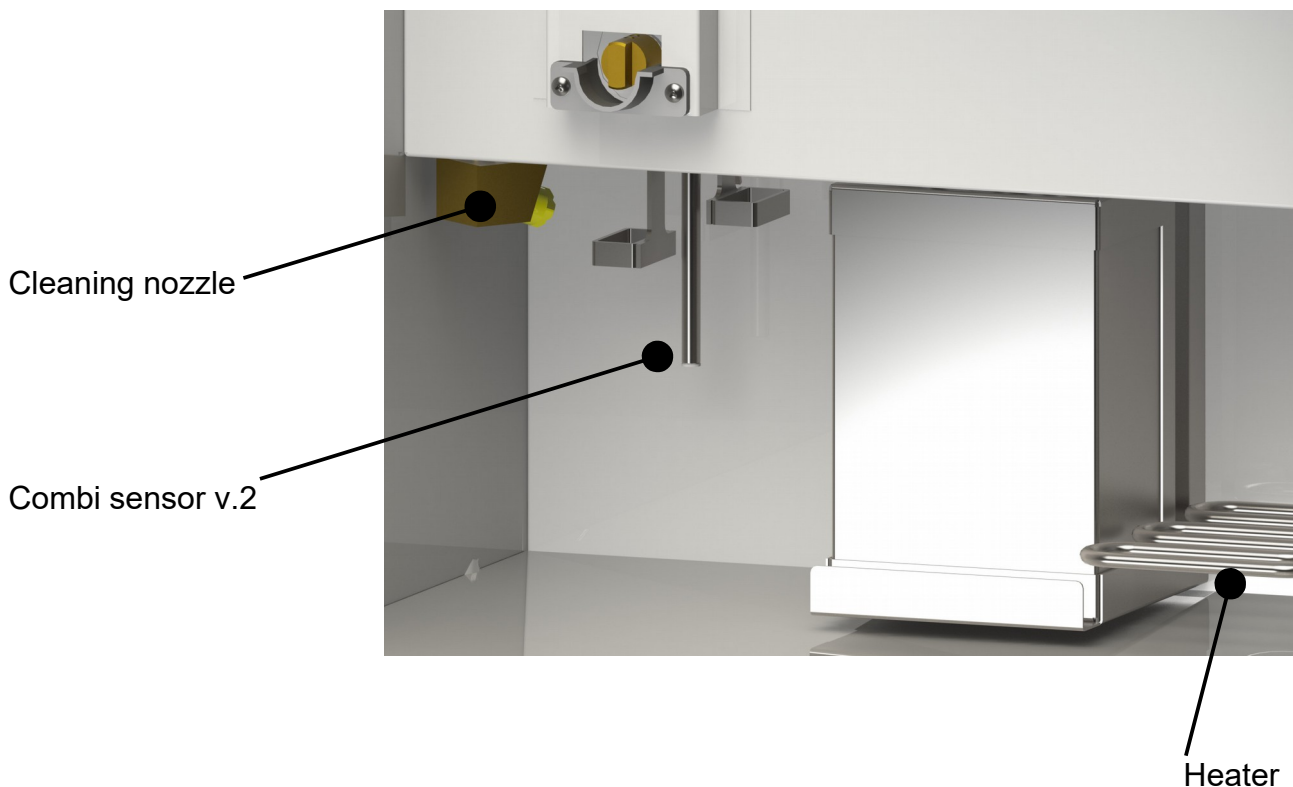

10.1.1 Cleaning the Wax Container

(at least 1x per week, according to requirements)

- Remove cover.
- If more than $\frac{3}{4}$ full, the waste wax container has to be emptied. This can be reused for less high-quality work.
- Reinsert container and replace cover.

10.1.2 Changing the Water

(at least every 6 weeks, according to requirements)

The water may need changing earlier or later, depending on use and water hardness.

Wax removal should be carried out before changing the water to keep the amount of wax in the drain hose as low as possible. This can occur early in the day, 30 minutes before the unit switches off automatically. The water temperature should be 90°C.

Follow the steps below when changing the water:

- Unit has to be heated to a water temperature of 90°C.
- Turn off tap and check drain hose is connected correctly to siphon or is hanging in wash basin.
- Set function switch to "Pump down".
- Switch on the pump by touching the symbol .
- The combi sensor is automatically cleaned by the cleaning nozzle (also see 8.1.3)
- After pump down (siphoned air will cause a gurgling noise), the pump has to be switched off by touching the display symbol a second time.
- Reset function switch to "Automatic scalding" position.
- Switch unit off completely (main switch on 0).
- The remaining water can now be removed with the wax drain container (lever vertical). Process has to be repeated several times as the container cannot hold all the remaining water.
- Important: Return drain lever to the horizontal after removing the remaining water.



Before refilling the unit the interior and the pump filter have to be cleaned.

The combi sensor v.2 is automatically cleaned by the cleaning nozzle during the pump down process (see 8.1.3) if it is very dirty see 8.1.4. It is important too to check for lime on the heater. Cleaning the roller brushes is neither necessary nor advisable.

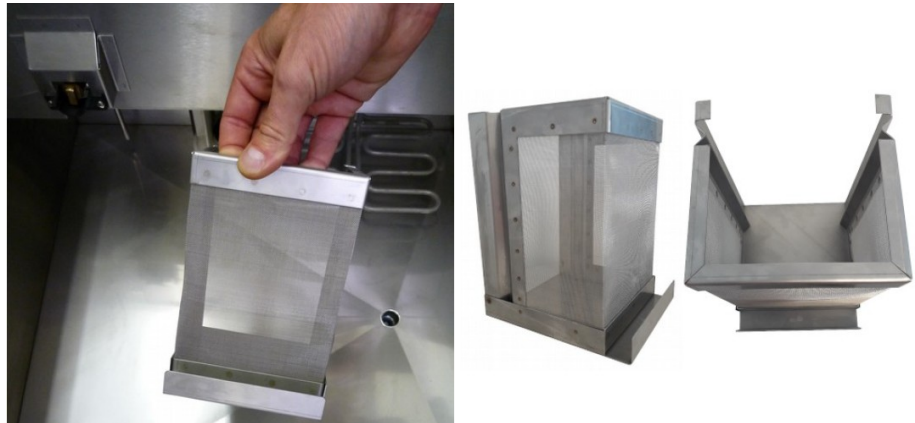
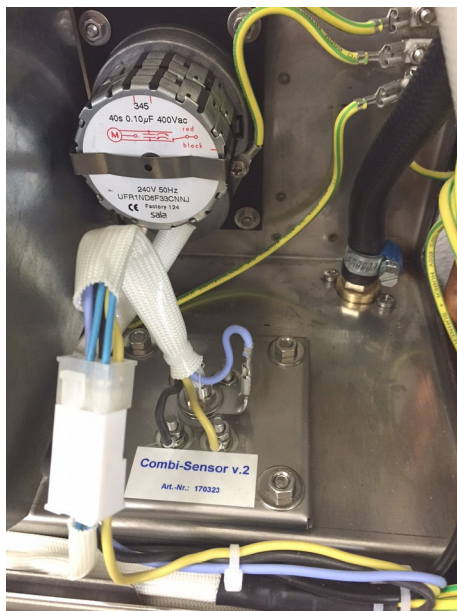

Fig.: Pump filter

10.1.3 Cleaning Procedure of the Combi Sensor v.2 (at least every 6 weeks, according to requirements)

- The system should be filled with water and wax remover as usual.
- Be sure that the system is heated to 90°C (194°F) or more.
- Start the pump down / drain mode (see also page 22 of the manual for this step)
- While pumping down the water out of the system, a small part of the flow goes through the nozzle and is cleaning the sensor with a spray of hot water.
- Be sure that the cleaning procedure (drain mode) is active for at least 4 minutes.
- The pump stops by pressing the “drain-symbol” on the display. Unlock the selector lever by pulling it up and set the selector lever back to “Automatic scalding” position. The heating restarts after 1 minute waiting time.
- Than the system can be filled again.

10.1.4 Dismount and Cleaning of the Combi Sensor v.2
(if it is very dirty, according to requirements)



The combi-sensor v.2 (REF 170323) is located below the cleaning roller (slightly off to the right).

(4x M5) unscrew the nuts



Pull off the sensor plug (6-pin)

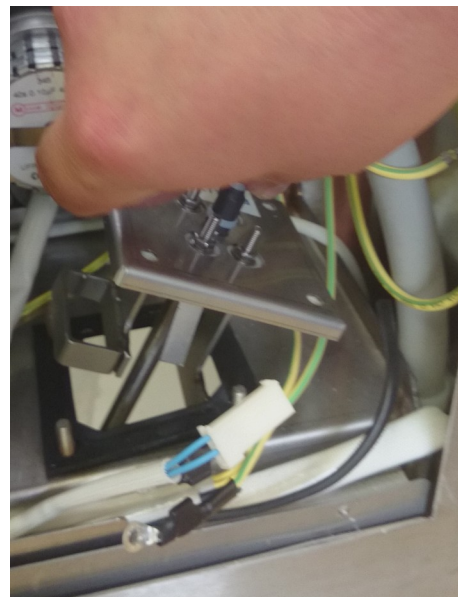

Remove the combi sensor v.2

- Disconnect the power plug before starting any maintenance work.
- Before dismounting, it is necessary to clean the unit.
- Dismount the side cover or open the door in the side cover.
- Dismount the combi sensor v.2. Use hot steam for cleaning.
- Mount the combi sensor v.2, reconnect the sensor plug (6-pin) correctly.

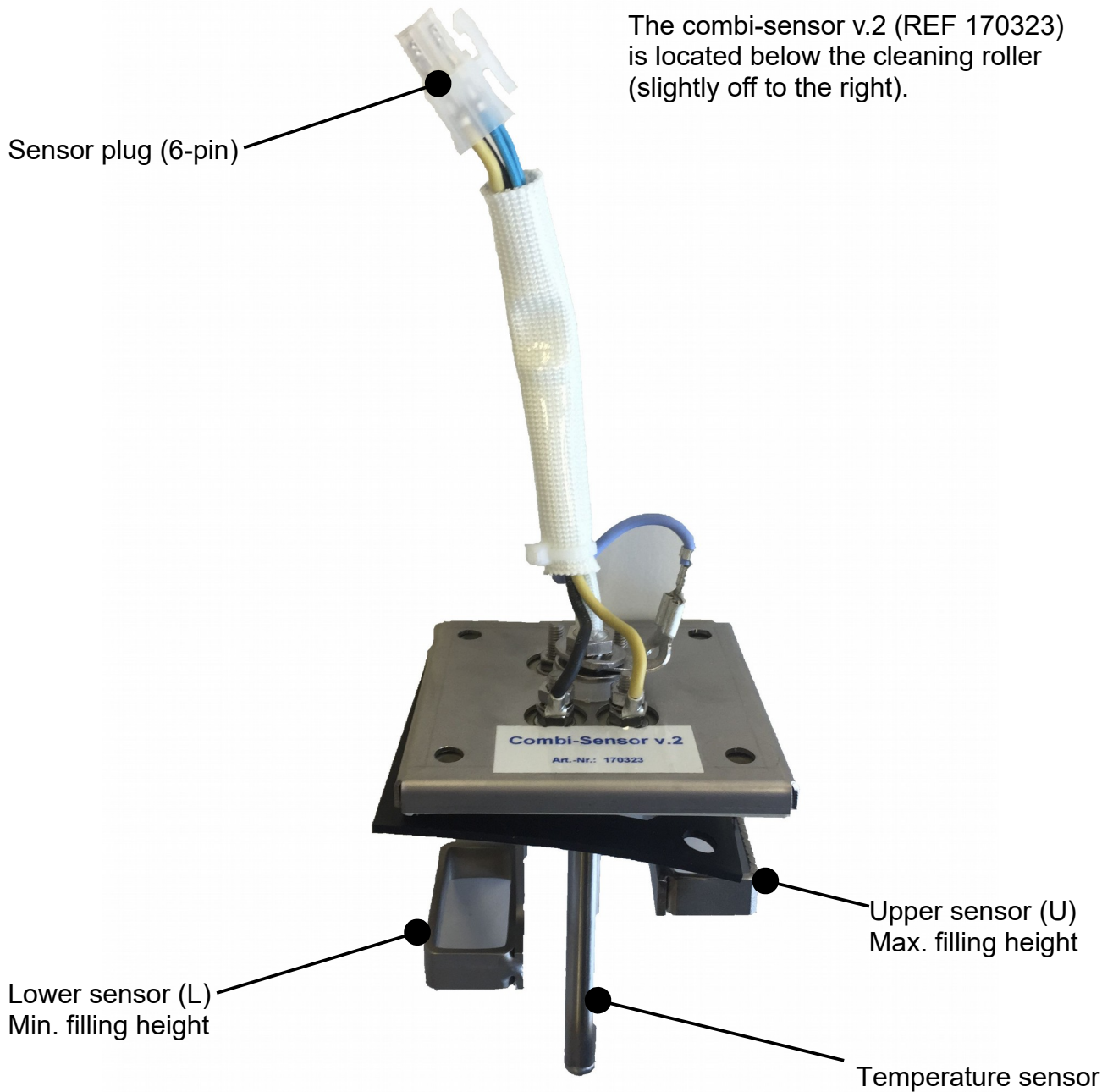

10.1.5 Lime Removal

(at least 6-monthly, according to requirements)

- Intermediate lime removal may be needed, depending on the build-up.
- Up to 500 ccm depending on instrument condition
- Drain water containing too much wax dissolver
- Mix Kalk-Ex in cold water



Allow KALK-EX max. 12 hours to work. Drain solution and rinse thoroughly.

Observe protective measures (wear wraparound protective glasses and suitable gloves). Avoid contact with skin, eyes and clothing. Do not swallow or breathe in lime remover. Otherwise seek medical help.

10.2 Maintenance

The unit does not require any servicing. Just make sure that the device is kept clean.



Warning:

Please check the leak tightness of the discharge hose (320061) at regular intervals to ensure trouble-free operation.

10.3 Repairs



Servicing or repairs to the unit has only to be carried out by qualified technicians.

Only original spare parts are to be used. Responsibility for the product is voided if unauthorized persons alter it or if inappropriate components are installed.

10.4 Spare Parts

If necessary please contact our service hotline phone.

10.5 Service Hotline 0049 (0)40 730 926 -20/ -24

10.6 Scope of Delivery/ Accessories

Wapo-Ex 12 II (supply line EU)	Item no.: 170970
Wapo-Ex 12 II (supply line USA)	Item no.: 170971

Included parts	Item no.:
Spray gallows	830145
Service set (1 L lime remover and 2 L wax remover)	170330
Supply hose with water inlet valve and gasket, 2 m	830011
Discharge hose, 2.5 m / hose clip Ø 12-20 x 9	320061 / 322006
Spray arm tube with seal	830160
2 flask baskets	2 x 830205
2 covers	830230 / 830235

Accessories	Item no.:
Service set (1 L lime remover and 2 L wax remover)	170330

10.7 Warranty



The warranty period for our equipment is 12 months. If faults occur within the warranty period, contact your dental depot or get in touch directly with our service department.

Your equipment should only be operated in perfect condition. If faults occur which could harm operators or third parties, the unit should not be used until it has been fixed.

This warranty does not cover damage caused by improper use, external mechanical causes, transport damage or interference with the unit by unauthorized persons.

11 Technical Data

Wapo-Ex 12 II (supply line EU)	Item No.: 170970
Wapo-Ex 12 II (supply line USA)	Item No.: 170971
Voltage	220–240 V / 50/60 Hz
Power consumption	12 A
Output	max. 3300 W
W x H (without spray gallows) x D	650 x 900 x 620 mm
W x H (with spray gallows) x D	650 x 1600 x 620 mm
Weight	87 kg
Sound level	≤ 70 dB (A)
Water capacity	approx. 50 l
Water feed rate	4,5 l / min
Water drain height	470 mm

Other voltages on request.

The noise level of the unit amounts to ≤ 70 dB (A).



Technical changes reserved.

12 Disposing of the Unit

The unit has to be disposed by an authorized recycling operation. The selected company has to be informed of all possibly health-hazardous residues in the unit.

12.1 Information on Disposal for Countries within the EU



To conserve and protect the environment, prevent environmental pollution and improve the recycling of raw materials, the European Commission adopted a directive that requires the manufacturer to accept the return of electrical and electronic units for proper disposal or recycling.

Within the European Union units with this symbol should not therefore be disposed of in unsorted domestic waste.

For more information regarding proper disposal please apply at your local authority.

13 EU Declaration of Conformity

in accordance with 2014/35/EU (Low Voltage Directive) and 2014/30/EU (Electromagnetic Compatibility Directive) and 2006/42/EC (Machinery Directive) and 2011/65/EU (RoHS Directive)

Manufacturer:	W A S S E R M A N N Dental-Maschinen GmbH Rudorffweg 15-17 21031 Hamburg Germany	Product description:	Boil Out Unit for dental applications
Model:	Wapo-Ex 12 II (supply line EU) Wapo-Ex 12 II (supply line USA)	Item no. 170970 Item no. 170971	
Applicable standards:	DIN EN 61010-1 DIN EN 60335-1 EN 55011 (2009) + A1 (2010) Störspannung/interference voltage (EN 55011 Class A) Störfeldstärke/interference field strength (EN 55011 Class B) EN 61326-1 (2013) EN 61000-3-2 (2006) +A1 (2009) + A2 (2009) EN 61000-3-3 (2013)		

Hiermit wird bestätigt, dass die oben bezeichnete Maschine den genannten EU-Richtlinien entspricht. Diese Erklärung wird ungültig, falls die Maschine ohne unsere Zustimmung verändert wird.

This is to confirm that the above mentioned machine complies with the described EU guidelines. This declaration becomes invalid if the machine is modified without our approval.

Cette machine est conforme aux normes en vigueur d'Union européenne. Cet avis est nul et non avenant si cette machine est modifiée sans notre accord.

Esta máquina, anteriormente mencionada, cumple con los límites requeridos por el reglamento UE. Ahora bien, esta declaración quedará invalidada en caso de realizar modificaciones al aparato sin nuestra aprobación.

Hiermee wordt bevestigd dat bovengenoemde machine voldoet aan de voorgeschreven EU normen. Deze verklaring verliest geldigheid als er zonder onze uitdrukkelijke toestemming wijzigen aan de machine worden aangebracht.

Place, date: Hamburg, 2021-04-23

Company stamp :



Signature: _____
Sven Wassermann
(Managing Director)



WASSERMANN
DENTAL-MASCHINEN GMBH
Rudorffweg 15-17 · 21031 Hamburg



Wassermann Dental-Maschinen GmbH
Rudorffweg 15–17 · 21031 Hamburg · Germany
Phone: +49 (0)40 730 926-20/ -24 · Fax: +49 (0)40 730 37 24
export@wassermann-dental.com · www.wassermann.hamburg



/WassermannDentalmaschinen